

Mixed Series & Parallel Circuits (Resistance Only)

Unit: DC Circuits

MA Curriculum Frameworks (2016): HS-PS2-9(MA)

AP® Physics 2 Learning Objectives: 4.E.4.1, 4.E.4.2, 4.E.4.3, 4.E.5.1, 4.E.5.2, 4.E.5.3

Mastery Objective(s): (Students will be able to...)

- Calculate voltage, current, resistance and power in mixed series & parallel circuits.

Success Criteria:

- Correct relationships are applied for voltage, current, resistance and power in mixed series & parallel circuits.
- Variables are correctly identified and substituted correctly into the correct equations.
- Algebra is correct and rounding to appropriate number of significant figures is reasonable.

Language Objectives:

- Explain the relationships for voltages, current, resistance and power in mixed series & parallel circuits.

Tier 2 Vocabulary: series, parallel

Labs, Activities & Demonstrations:

- light bulb mystery circuits

Notes:

If a circuit has mixed series and parallel sections, you can determine the various voltages, currents and resistances by applying Kirchhoff's Rules and/or by "simplifying the circuit." Simplifying the circuit, in this case, means replacing groups of resistors that are in series or parallel with a single resistor of equivalent resistance.

Use this space for summary and/or additional notes:

For example, suppose we need to solve the following mixed series & parallel circuit for voltage, current, resistance and power for each resistor:

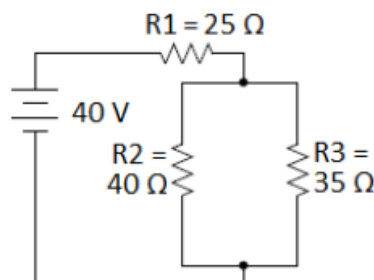

Because the circuit has series and parallel sections, we cannot simply use the series and parallel rules across the entire table.

	R ₁	R ₂	R ₃	Total
Voltage (ΔV)				40 V
Current (I)				
Resistance (R)	25 Ω	40 Ω	35 Ω	
Power (P)				

We can use Ohm’s Law ($\Delta V = IR$) and the power equation ($P = I\Delta V$) on each individual resistor and the totals for the circuit (columns), but we need two pieces of information for each resistor in order to do this.

Our strategy will be:

1. Simplify the resistor network until all resistances are combined into one equivalent resistor to find the total resistance.
2. Use $\Delta V = IR$ to find the total current.
3. Work backwards through your simplification, using the equations for series and parallel circuits in the appropriate sections of the circuit until you have all of the information.

Step 1: If we follow the current through the circuit, we see that it goes through resistor R1 first. Then it splits into two parallel pathways. One path goes through R2 and R3, and the other goes through R4 and R5.

There is no universal shorthand for representing series and parallel components, so let’s define the symbols “—” to show resistors in series, and “||” to show resistors in parallel. The above network of resistors could be represented as:

$$R_1 - (R_2 \parallel R_3)$$

Now, we simplify the network just like a math problem—start with the innermost parentheses and work your way out.

Use this space for summary and/or additional notes:

Step 2: Combine the parallel $40\ \Omega$ and $35\ \Omega$ resistors into a single equivalent resistance:

$$25\ \Omega - (40\ \Omega \parallel 35\ \Omega) \rightarrow 25\ \Omega - (R_{eq,||})$$

$$\frac{1}{R_{total}} = \frac{1}{40} + \frac{1}{35}$$

$$\frac{1}{R_{total}} = 0.0250 + 0.0286 = 0.0536$$

$$R_{total} = \frac{1}{0.0536} = 18.\bar{6}\ \Omega$$

Now our circuit is equivalent to:

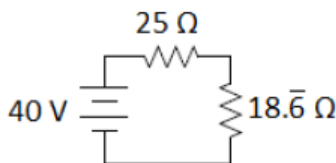

Step 3: Add the two resistances in series to get the total combined resistance of the circuit:

$$25\ \Omega - 18.\bar{6}\ \Omega \rightarrow R_{total}$$

$$18.\bar{6} + 25 = 43.\bar{6}\ \Omega$$

This gives:

	R_1	R_2	R_3	Total
Voltage (ΔV)				40 V
Current (I)				
Resistance (R)	25 Ω	40 Ω	35 Ω	43.$\bar{6}$ Ω
Power (P)				

Use this space for summary and/or additional notes:

Step 4: Now that we know the total voltage and resistance, we can use Ohm's Law to find the total current:

$$\Delta V = IR$$

$$40 = I(43.\bar{6})$$

$$I = \frac{40}{43.\bar{6}} = 0.916 \text{ A}$$

While we're at it, let's use $P = I\Delta V = (0.916)(40) = 36.6 \text{ W}$ to find the total power.

	R ₁	R ₂	R ₃	Total
Voltage (ΔV)				40 V
Current (I)				0.916 A
Resistance (R)	25 Ω	40 Ω	35 Ω	43. $\bar{6}$ Ω
Power (P)				36.6 W

Now we work backwards.

The next-to-last simplification step was:

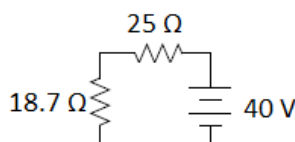

The 25 Ω resistor is R₁. All of the current goes through it, so the current through R₁ must be 0.916 A. Using Ohm's Law, this means the voltage drop across R₁ must be:

$$\Delta V = IR = (0.916)(25) = 22.9 \text{ V}$$

and the power must be:

$$P = I\Delta V = (0.916)(22.9) = 21.0 \text{ W}$$

This means that the voltage across the parallel portion of the circuit (R₂ || R₃) must be $40 - 22.9 = 17.1 \text{ V}$. Therefore, the voltage is 17.1 V across *both* parallel branches (because voltage is the same across parallel branches).

	R ₁	R ₂	R ₃	Total
Voltage (ΔV)	22.9 V	17.1 V	17.1 V	40 V
Current (I)	0.916 A			0.916 A
Resistance (R)	25 Ω	40 Ω	35 Ω	43. $\bar{6}$ Ω
Power (P)	21.0 W			36.6 W

Use this space for summary and/or additional notes:

We can use this and Ohm's Law to find the current through one branch:

$$\Delta V_{40\Omega} = \Delta V_{35\Omega} = 40 - \Delta V_1 = 40 - 22.9 = 17.1V$$

$$\Delta V_{40\Omega} = I_{40\Omega} R_{40\Omega}$$

$$I_{40\Omega} = \frac{\Delta V_{40\Omega}}{R_{40\Omega}} = \frac{17.1}{40} = 0.428 A$$

We can use Kirchhoff's Junction Rule to find the current through the other branch:

$$I_{total} = I_{40\Omega} + I_{35\Omega}$$

$$0.916 = 0.428 + I_{35\Omega}$$

$$I_{35\Omega} = 0.488 A$$

This gives us:

	R ₁	R ₂	R ₃	Total
Voltage (ΔV)	22.9 V	17.1 V	17.1 V	40 V
Current (I)	0.916 A	0.428 A	0.488 A	0.916 A
Resistance (R)	25 Ω	40 Ω	35 Ω	43. $\bar{6}$ Ω
Power (P)	21.0 W			36.6 W

Finally, because we now have current and resistance for each of the resistors R_2 and R_3 , we can use $P = I\Delta V$ to find the power:

$$P_2 = I_2 \Delta V_2 = (0.428)(17.1) = 7.32 W$$

$$P_3 = I_3 \Delta V_3 = (0.488)(17.1) = 8.34 W$$

	R ₁	R ₂	R ₃	Total
Voltage (ΔV)	22.9 V	17.1 V	17.1 V	40 V
Current (I)	0.916 A	0.428 A	0.488 A	0.916 A
Resistance (R)	25 Ω	40 Ω	35 Ω	43. $\bar{6}$ Ω
Power (P)	21.0 W	7.32 W	8.34 W	36.6 W

Alternately, because the total power is the sum of the power of each component, once we had the power in all but one resistor, we could have subtracted from the total to find the last one.

Use this space for summary and/or additional notes:

Homework Problems

1. **(M)** What is the equivalent resistance between points **A** and **B**?

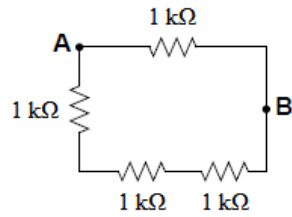

Answer: 750Ω

2. **(M)** What is the equivalent resistance between points **A** and **B**?

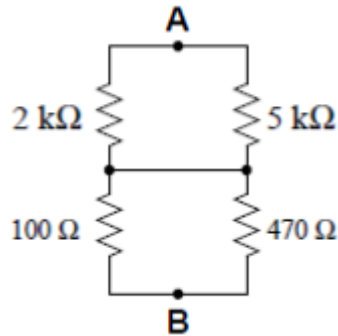

Hints:

- Convert the resistances from $k\Omega$ to Ω .
- Redrawing the circuit to separate the top and bottom halves may make it easier to understand what is going on.

Answer: 1511Ω or $1.511 k\Omega$

Use this space for summary and/or additional notes:

3. (M) What is the equivalent resistance between points A and B?

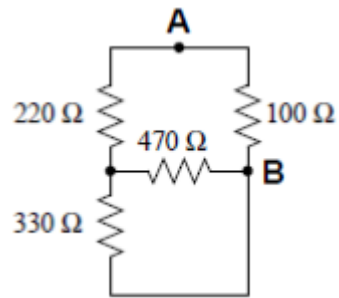

(The space below is intentionally left blank for calculations.)

Answer: 80.5 Ω

Use this space for summary and/or additional notes:

4. (M) Fill in the table for the circuit below:

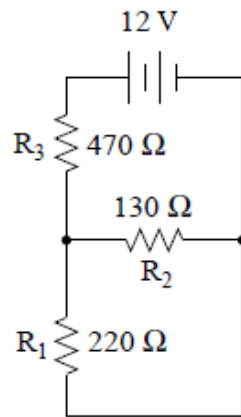

	R ₁	R ₂	R ₃	Total
Voltage (ΔV)				12 V
Current (I)				
Resistance (R)	220 Ω	130 Ω	470 Ω	
Power (P)				

(The space below is intentionally left blank for calculations.)

Use this space for summary and/or additional notes: